



EN - Use and installation manual

EN - Induction vitroceramic hob

Model:

7300001



Dear customer!

This appliance is intended for household use only.
 Materials used for packaging are nature friendly and may be recycled, deposited or destroyed without any threats to the environment. In order to recognize these features, all packing materials are marked with relevant symbols.
 Once your appliance has become obsolete and you do not intend to use it any longer, take adequate care not to litter the environment. Deposit your old appliance with the authorized depot dealing with used household appliances.

Instructions for use

Instructions for use describe the appliance and the way it is handled.
 These instructions are intended for various types of appliances, so you can find some descriptions of functions that your particular appliance may not have.

These instructions are only valid for the country indicated on the appliance. If there is NO country on the appliance, technical instructions should be observed for adapting the appliance to comply with the requirements and regulations in your country.

Instructions for connection

The appliance must be connected in compliance with the instructions attached to it, as well as in compliance with relevant regulations and standards. The connection may only be performed by a qualified person.

Rating plate

The rating plate indicating the basic information is attached on the bottom of the appliance.

The Manufacturer strives for continuous improvements. For this reason, the text and illustrations in this book are subject to change without notice.

Keep these instructions in a safe place and ensure that new users are familiar with the contents. Pass them on to any future owner.

Installation	3
Connection to the power supply	5
Technical information	7
Appliance introduction	8
Safety functions and error display	21
Cleaning and maintenance	22

IMPORTANT WARNINGS

- The appliance and its accessible parts become hot during use. Care should be taken to avoid touching heating elements. Children less than 8 years of age shall be kept away unless continuously supervised.
- Prevent the children to hang around the appliance and warn them properly against the danger of burns.
- This appliance can be used by children aged from 8 years and above, and persons with reduced physical, sensory or mental capabilities or lack of experience and knowledge if they have been given supervision or instruction concerning use of the appliance in a safe way and understand the hazards involved.
- Children shall not play with the appliance.
- Cleaning and user maintenance shall not be made by children without supervision.



- Unattended cooking with fat or oil can be dangerous and may result in fire. Be sure having the preparation of such food (fries) under constant control. Never try to extinguish a fire with water, but switch off the appliance and then cover flame e.g. with a lid or a fire blanket.



- Danger of fire: do not store items on the cooking surfaces.



- If the surface is cracked, switch off the appliance to avoid the possibility of electric shock.
- Don't use high-pressure steam cleaner or hot steam to clean the appliance.
- Never place any metal objects upon the appliance surface, such as knives, forks, spoons, pot lids, and the like, as they may get very hot.
- The appliance can not be activated by external timers or remote controls systems.
- Do not use the appliance for room heating.
- If there is a wall power outlet located near the appliance and another appliance is plugged into it, make sure the power cord does not come into contact with the hot cooking zones.
- Do not store any temperature-sensitive objects, materials, or substances underneath the appliance, e.g. detergents, sprays, etc.
- In case of a failure of the appliance, immediately disconnect the appliance from the power mains and contact the service center.
- The appliance is manufactured in compliance with the relevant effective safety standards.
- Don't connect the appliance to the power supply with an extension cable or multiple sockets, because they don't assure a sufficient safety (e.g. overheating risk of multiple sockets).
- Connect the appliance to a permanent connection.
- Installation of the appliance into a kitchen worktop and its connection to the power mains may only be performed by an adequately qualified technician.
- Do not place empty pans on the appliance.
- Appliance surface should not be used as a worktop. Sharp objects may cause scratches.
- Preparing food in thin aluminum or plastic containers on the cooking zones is not allowed. Do not place any plastic objects or aluminum foil on the appliance surface.
- After a prolonged use of cast iron plates, the area of the plate and the edge of the cooking zone may faded. Repair service is not covered by the warranty.
- If the appliance is built-in over an oven with a pyrolytic system, it should not be operated while the pyrolytic process is in progress because it can trigger its overheating protection.



The symbol on the product or on its packaging indicates that this product may not be treated as household waste. Instead it shall be handed over to the applicable collection point for the recycling of electrical and electronic equipment. By ensuring this product is disposed of correctly, you will help prevent potential negative consequences for the environment and human health, which could otherwise be caused by inappropriate waste handling of this product. For more detailed information about recycling of this product, please contact your local city office, your household waste disposal service or the shop where you purchased the product.

INSTALLATION

Important warnings

- Installation of the appliance into a kitchen worktop must be performed by an adequately qualified technician.
- Veneer or other finish of the piece of kitchen furniture into which the hob is to be built in should be treated with heat resistant glue (100°C); otherwise, the worktop finish may be discolored or deformed.
- Ideally the appliance should be installed with plenty of space on either side. There may be a wall at the rear and a tall unit or wall at one side. On the other side, however, no unit or divider should stand higher than the appliance.

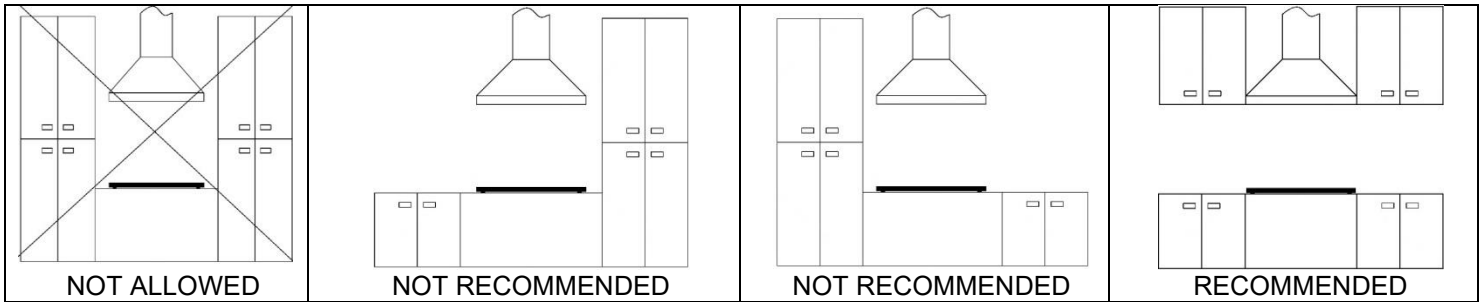

- The distance between the appliance edge and the adjacent tall kitchen furniture element should amount to no less than 250 mm.
- All sizes and distances to be taken for the proper functioning of the appliance are shown in figures below.
- The kitchen furniture element underneath the hob should not be fitted with a drawer. If the kitchen furniture element as a horizontal partition wall, it should be installed no less than min 20mm from the lower surface of the appliance. The space between the partition wall and the appliance must be empty; no objects should be placed into that gap.
- Hanging, or wall-mounted kitchen elements should be installed high enough not to interfere with the work process.
- A minimum safety distance must be maintained between the appliance and the cooker hood above it. See the cooker hood manufacturer's operating and installation instructions for details. If the manufacturer's instructions are not available or, if there are any flammable objects (e.g. utensil rails, wall units etc) above the appliance, a minimum safety distance of at least 800 mm must be maintained between them and the appliance below.
- Fit the wall units and cooker hood before fitting the appliance to avoid damaging it.
- The front part must have an opening of no less than 5 mm.
- The appliance must not be installed over a fridge, fridge-freezer, freezer, dishwasher, washing machine, washer-dryer or tumble dryer.
- **Only ovens fitted with a cooling fan may be installed underneath this appliance.**
- Before installing an oven, the rear wall of the kitchen furniture element should be removed in the area of the appliance cut-out. Furthermore, a gap of at least 5 mm should be left at the front side.

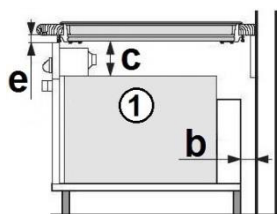

a	≥ 800 mm
b	≥ 50 mm
c	≥ 20 mm
d	≥ 80 mm
e	≥ 5 mm
f	≥ 30 mm
g	≥ 250 mm

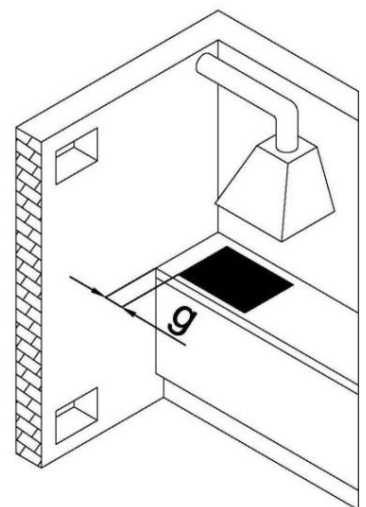
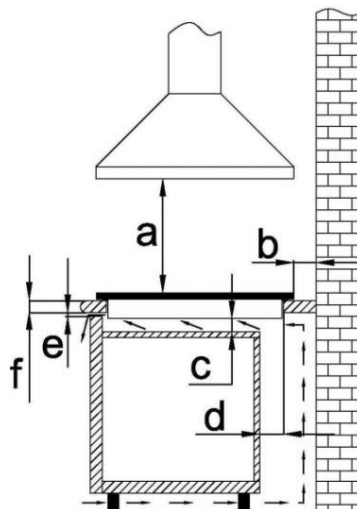

BUILT-IN SIZES

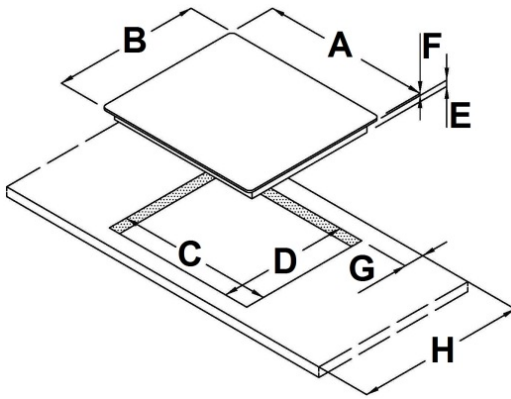

	7300001
A	920
B	520
C	908
D	504
E	55 mm
F	6 mm
G	≥ 50 mm
H	≥ 600 mm

Installing the foam gasket (for glass appliances)

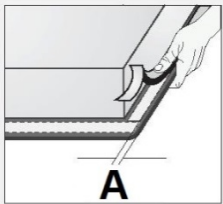

Before inserting the appliance into the opening in the kitchen worktop, the supplied foam gasket must be attached to the lower side of the glass.

Do not install the appliance without the foam gasket!

The gasket should be attached to the appliance in the following way:

- Remove the protective film from the gasket.
- Attach the gasket to the lower side approximately **A**=2-3 mm from the edge. The gasket must be attached along the entire length and should not overlap at the corners.
- When installing the gasket, make sure that the glass does not come into contact with any sharp objects.

CONNECTION TO THE POWER SUPPLY

- The appliance may **ONLY** be connected by an authorized qualified technician.
- Electric system protection should comply with all relevant regulations.
- The connection clips can be accessed when the connection clip covers are opened / removed.
- Before connecting the appliance, make sure the voltage indicated on the rating plate is consistent with the voltage in your home network. Connection voltage should be checked by a qualified technician using a corresponding measuring device!
- The rating plate with basic information is attached on the lower side of the appliance.
- In order to make a fixed connection to the mains, insert an all-pole circuit breaker between the appliance and the mains. This device shall have a contact separation in all poles, providing full disconnection under overvoltage category III conditions.
- The current conducting and isolated parts must be protected from any possibility of direct contact.
- Before any intervention, disconnect the appliance from the power mains. Connect the appliance in compliance with the electric connections diagram supplied; make sure the relevant network voltage is observed!
- The ground wire should be connected to the clip indicated by the earth symbol.
- The mains cable should be fed through the fastening clip which protects it from being accidentally pulled out.
- After connecting the appliance, turn on all cooking zones / heaters for approximately three minutes to make sure they are operating correctly.
- Incorrect connection may destroy parts of the appliance, making the warranty void!
- Connection cable on the back of the appliance should be led in such way that it DOES NOT touch the appliance back wall, as this part will get very hot during operation.
- The appliance is generally configured to the maximum available power, shown in the technical data table. It's possible to set an operating mode with power limitation. This setting can be made at the time of installation or subsequently by a specialized technician. See chapter on power limitation setting.



Installation diagram

Use cables type: H05V2V2-F



LIVE	L1 – L2 – L3	BROWN – BLACK - GREY
EARTH		GREEN / YELLOW
NEUTRAL	N1 – N2	BLUE

Model	Supply Voltage / Frequency	Number of phases	Power cable section	Connection
7300001	220-240 V~ 50/60 Hz	1 phase + N	5 x 2,5 mm ²	
	380-415 V ~ 50/60 Hz	3 phases + N	5 x 1,5 mm ²	

WARNING! THIS APPLIANCE MUST BE GROUNDED

The electrical safety of this appliance can only be guaranteed when continuity is complete between it and an effective earthing system, which complies with current local and national safety regulations.

You can access terminal block at the bottom of the appliance. Open terminal block with the use of a screwdriver with a slotted tip. Make electrical connection as shown in the table above, depending on the model purchased and the type of electrical connection.

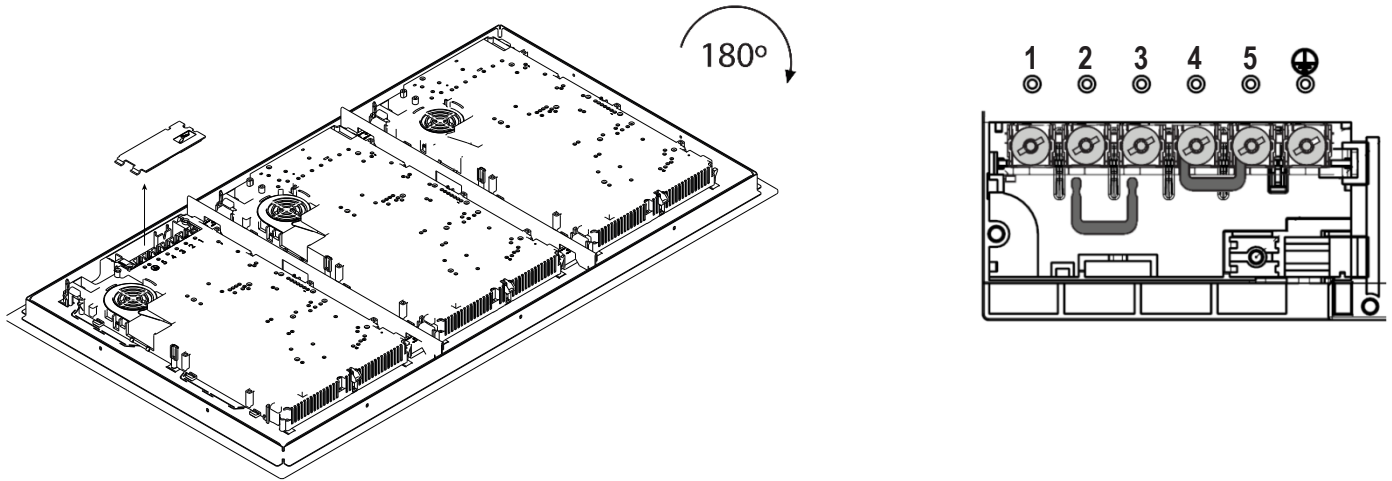

Basic adaptation of environment sensors

After each connection to electrical network, basic adaptation is automatically performed which ensures the optimal function of the sensors. All displays light up for a few seconds. During sensor adaptation, there must be no objects. If not, the adaptation stops until you remove the objects. During this time you cannot use the cooking panel.

SYSTEM POWER SETTINGS

- The cooktop must be connected to the power supply for max. 1 minute.
- The cooktop must be switched OFF.
- Press simultaneously anywhere on the left region and on the right region in the lower half area of the display for 2 seconds.
- Values starting from 2.4kW up to 11.0 kW in 100W steps can be chosen.
- Select the power level with the selection wheel and save with the confirm button.

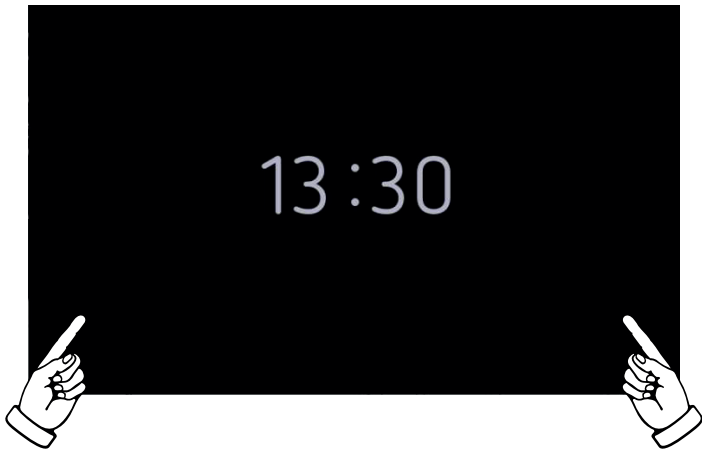

TECHNICAL INFORMATION

MODEL	7300 001
SUPPLY VOLTAGE	220-240 V 1N 380-415 V 3N
SUPPLY FREQUENCY	50 / 60 Hz
COOKING AREA	870 x 384 mm
TOTAL POWER	11000 W
EC ELECTRIC COOKING ENERGY CONSUMPTION FOR THE HOB [Wh/kg]	179,6 Wh/kg
NOMINAL POWER	2600 W
BOOSTER POWER	3650 W

APPLIANCE INTRODUCTION

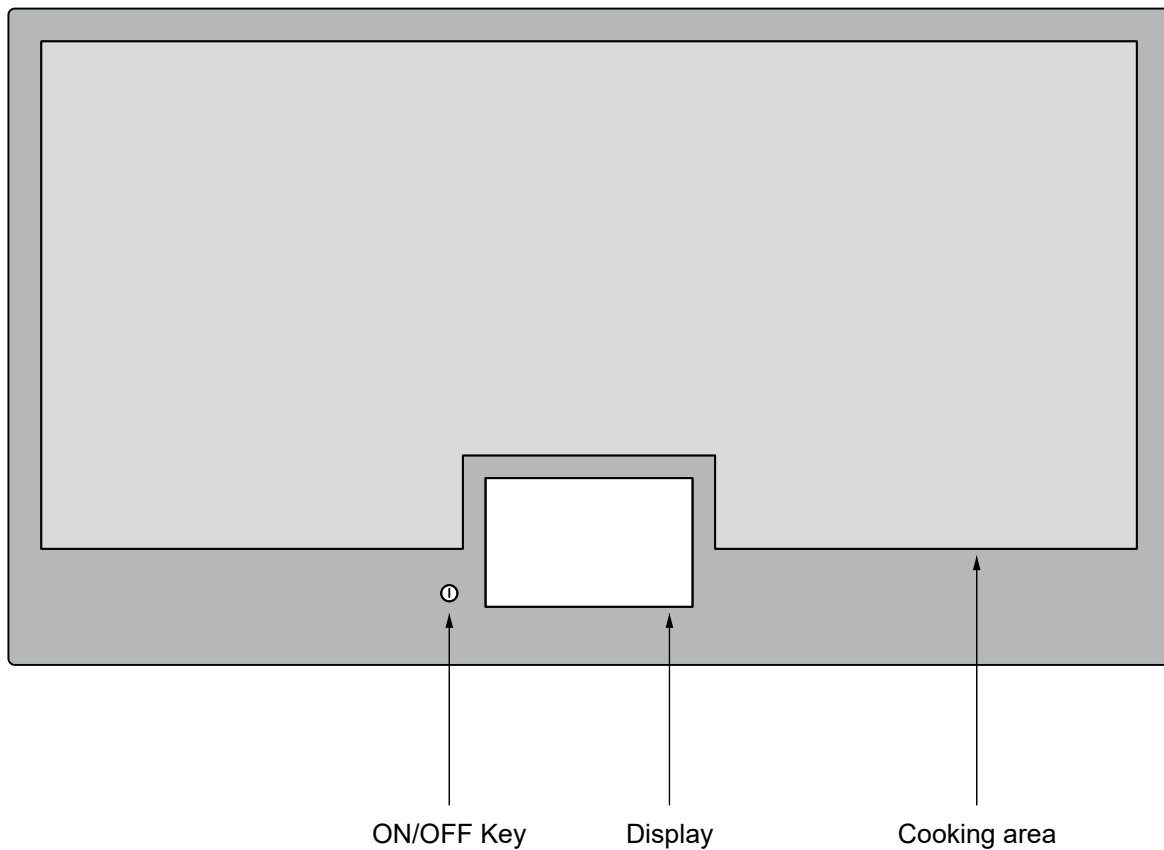

First Connection

At the first connection to the power supply, or after an interruption and a restoration, the display shows the factory preset time for about 20 seconds.

Turning the hob ON

Press the ON/OFF button to turn on the appliance. When turned on, the display shows the initial screen accompanied by an acoustic signal.

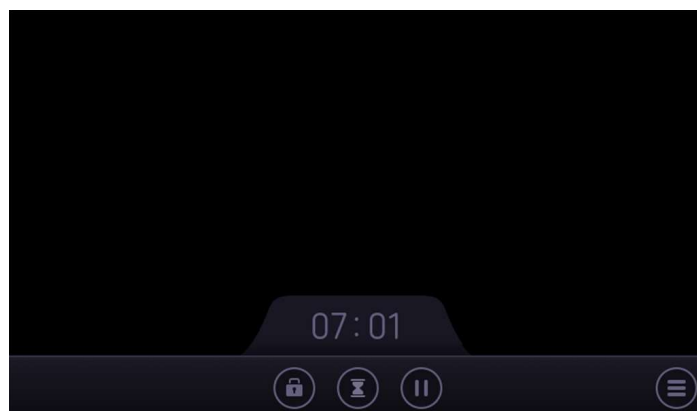

Turning the hob OFF

To turn off the device, press the ON/OFF button until an acoustic signal is emitted. The current time is displayed for about 20 seconds.

COOKWARE DETECTION

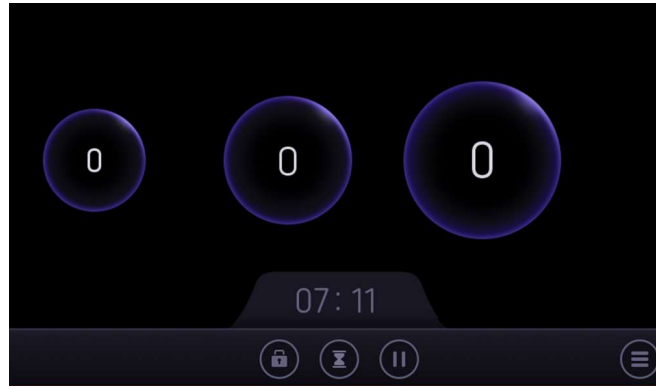

Cookware is automatically detected when the hob is switched on. Do not place metal objects such as knives, forks, spoons and lids on the surface of the hob, they may become hot.

- There are no fixed cooking zones. The pot can be placed and operated anywhere inside the cooking area of the cooktop.
- The pot is displayed according to its size and position on the cooktop in the main screen.
- There are three standard pot sizes: small, medium, big. Pots are always displayed with a round shape.

COOKWARE PLACING

- The glass ceramic surface is dimensioned to accommodate up to a maximum of 6 containers simultaneously.
- For correct pot detection and for efficient heat transmission is preferable to use circular pans of the following sizes:

Min. circumference: 145 mm

Max. circumference: 280 mm

- Small pots between 100-145mm in circumference won't be detected everywhere in the cooking area.
- Oversize cookware must be placed on the back section of the cooking area only.

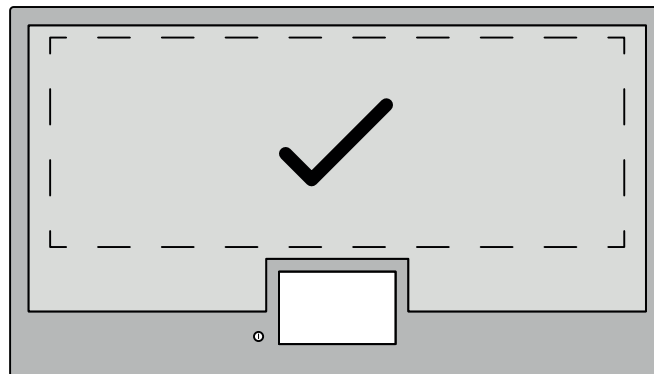

- Large pots might appear on the display as two different elements. Move the pot slightly or place it again on the surface until it is recognised.
- Always keep pots a few centimeters apart.



Pots should only be placed inside the cooking area, never place them too close to the display.

POWER LEVEL SETTING

•With the appliance switched on, place a pan suitable for induction cooking on the glass ceramic surface.

The display represents the pot as a circle:

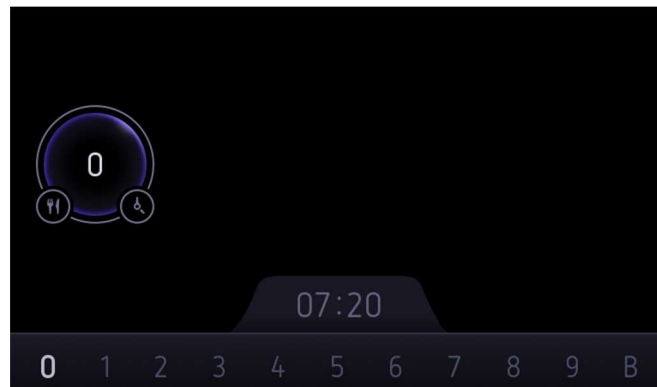

After a few moments of inactivity, the pot is deselected and will be need to touch the circle on display to select it again.

- A power setting can be selected using the bar at the bottom of the display.
- Select a level of power by tapping or sliding your finger up to the corresponding number.
- Power levels can be selected intermediate between integers, identifiable by points between one number and another.

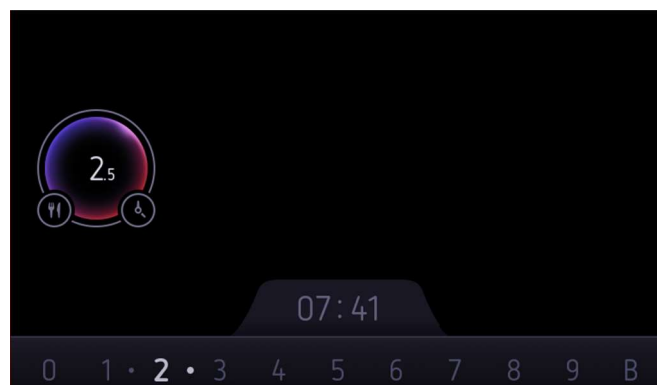

•To stop the supply of energy and the heating of the pan, you can perform the following actions at any time:

- Select power level 0
- Tap twice on the pot on the display
- Turn the hob off

•Dependent of the status of the pot, the pot shape is changing its color, ranging from blue to orange

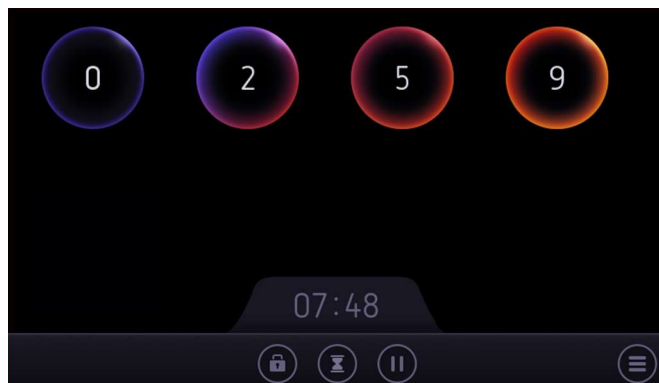

Power level	Use
0	OFF
1-2	Slow simmer, mantining warm food
3-4	Cooking small amounts
5-6	Cooking larger quantites, roasting larger chunks
7-8	Roasting, browning
9	Roasting
B	Boiling big amounts of water (Booster)

BOOST FUNCTION

- The booster enables the induction to provide a higher power for a pot for a short period of time (10 min).
- This is useful to heat-up/boil a big amount of water



As the booster function may reach high temperatures, it must only be used for cooking processes using water. Oil or fat may start to burn if booster is used.

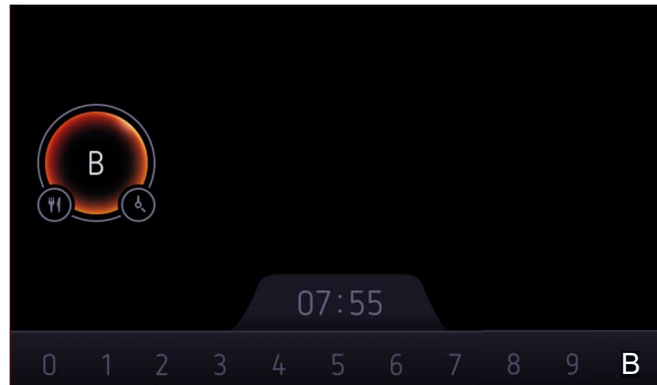

← Tap to activate

DE-ACTIVATION OF THE BOOSTER

- Select any other cooking level for the pot by slider if the booster function is currently active.
- Deactivate boost function by activation of a pot program.
- Deactivation by induction system due to temperature or power management.
- The boost function is terminated and deactivated automatically after boost - time of 10 min. Power level 9 is set, and sound emitted.
- The boost function can be reactivated after expiration of the boost time if the temperature conditions allow it.

POT PROGRAMS

- The pot program menu contains various functions for the preparation of food.
- To enter the menu select the required pot by touching inside the pot icon.
- Select the knife and fork icon of the pot.
- The pot program menu opens

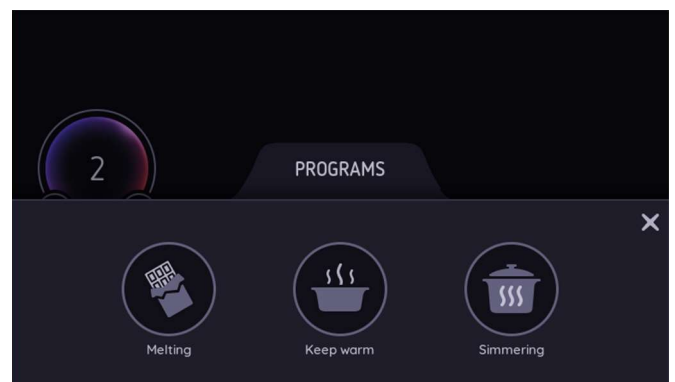
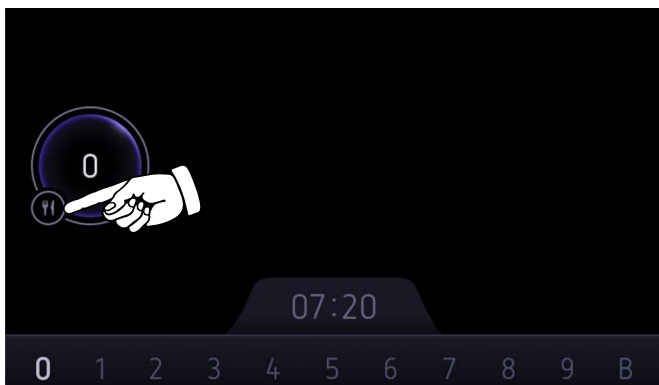

- Pot Program can be exited:
 - by touching the X icon
 - by touching the area above the pot program menu
 - by the expiry of timeout counter

MELTING FUNCTION

- The melting function is especially used for melting chocolate.
- The function sets the temperature of the induction coil sensor to 44°C.

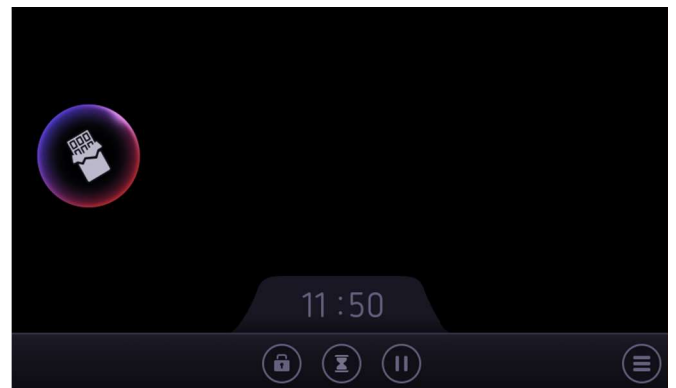
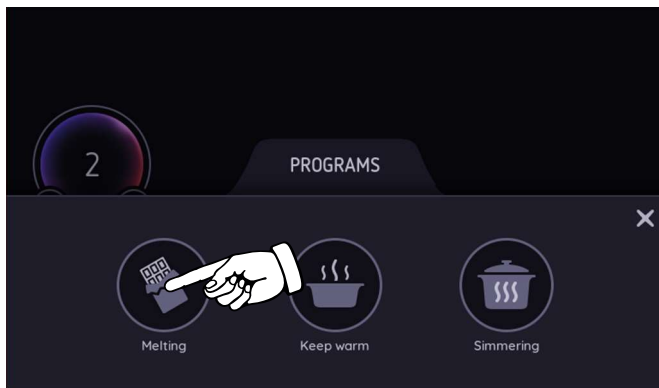

KEEP WARM FUNCTION

- This function is commonly used to keep food warm.
- The function sets the temperature of the induction coil sensor to 70°C.

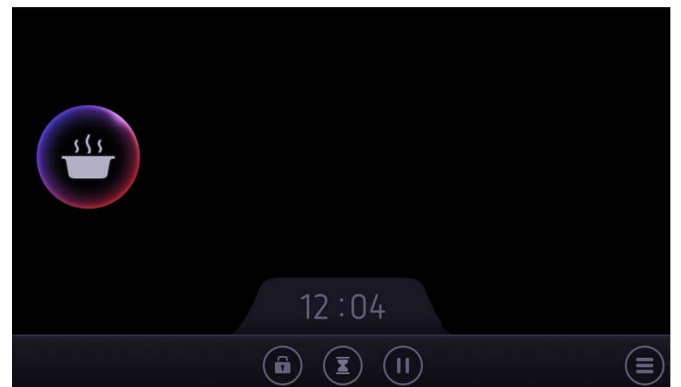
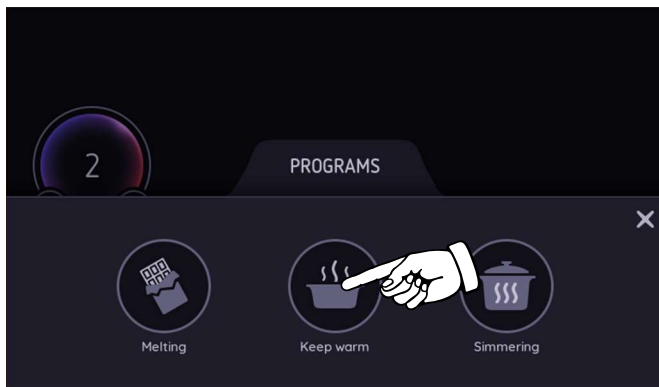

SIMMERING FUNCTION

- The function sets the temperature of the induction coil sensor to 94°C.

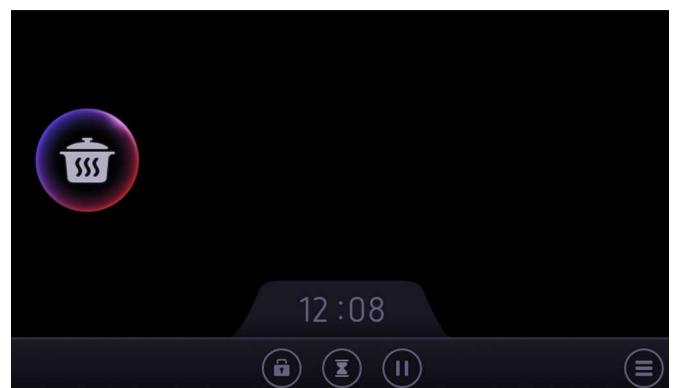
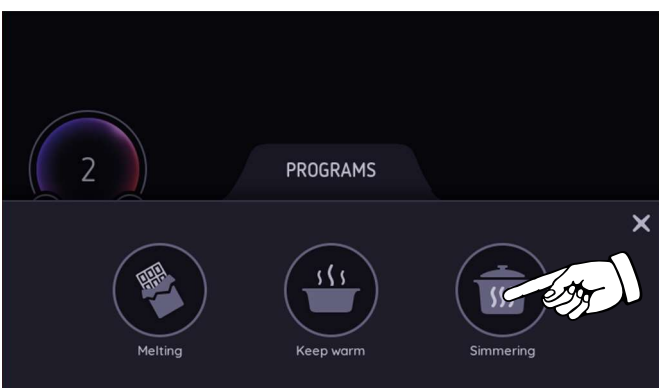

DEACTIVATING A POT PROGRAM

- Change the power level on the slider.
- Select the activated simmering function in the functions menu to deactivate it.
- Double tap on pot

COOKING TIMER

- Pot timers can be used to switch OFF a pot automatically after the set time has run out.
- While the timer is running, the cooking zone can be operated normally (i.e. cooking level can be changed).
- Each pot has an independent timer. All pot timers can run in parallel.
- Select the required pot by touching inside the pot icon and select the clock icon of the pot.

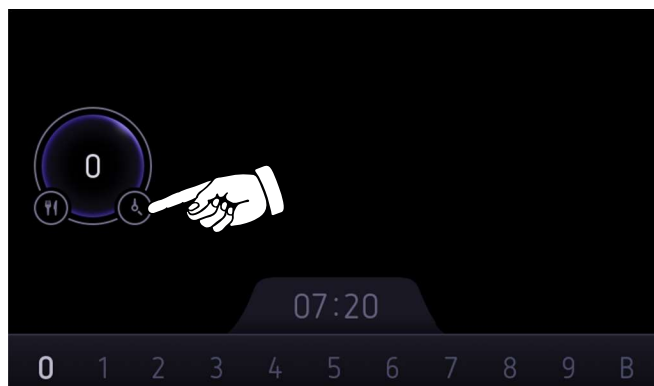

- Adjust the numbers for the timer on the hours and minute wheels, then confirm the setting on the confirm icon.

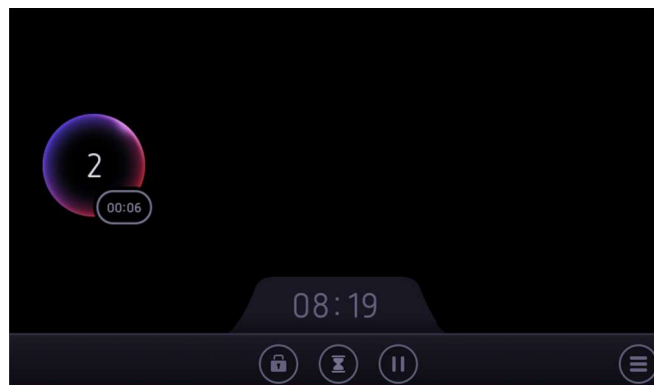
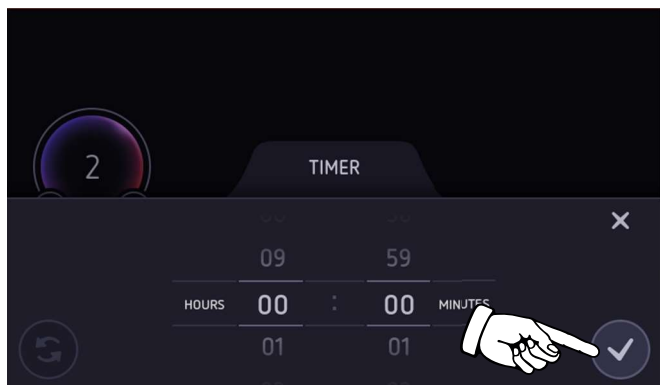

- The timer starts counting backwards. Beneath 1 hour, the display shows the current time accurate to the second.
- If the timer expired, a signal tone will be emitted, and the timer numbers are highlighted and flashing.
- The cooking level is switched off.
- Confirm the timer by touching the flashing timer values or by removing the pot or by waiting 35 seconds.

CHANGING THE VALUE AND DE-ACTIVATION

- Touch the pot timer values on the pot display.

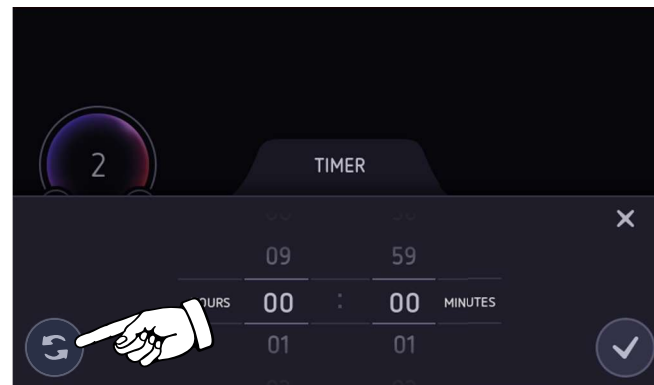
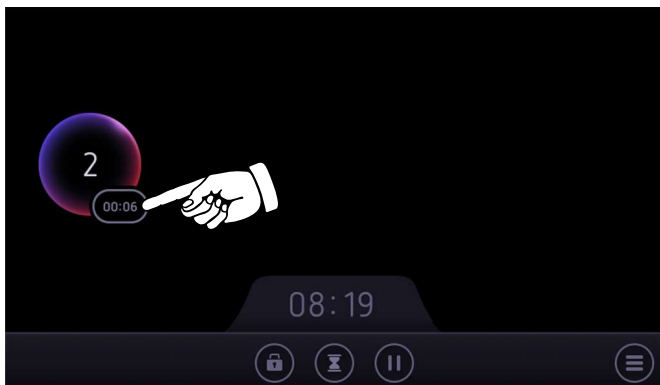

- To change the value adjust the numbers for the timer on the number wheels and confirm by touching the tick icon.
- To deactivate the timer touch the reset icon or set timer values to 00:00 and confirm by touching the tick icon.

MENU BAR FUNCTIONS

KEY LOCK

- Key lock is a functionality intended to lock the display while the cooktop is in operation.
- This is useful for cleaning purposes.
- To activate touch the Key Lock icon in the menu bar.
- The display screen except the Key Lock icon and the ON/OFF key are locked.
- To de-activate this function touch the Key Lock icon for 3 seconds.

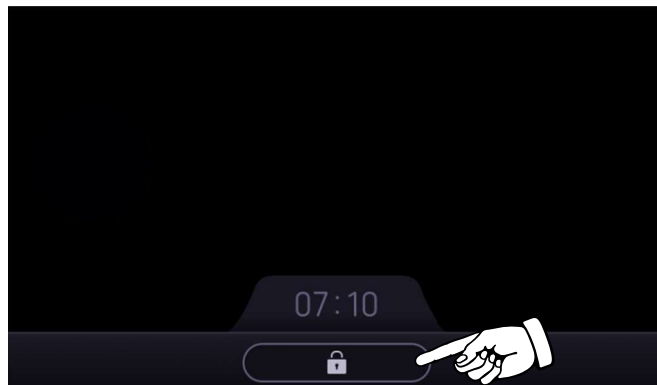
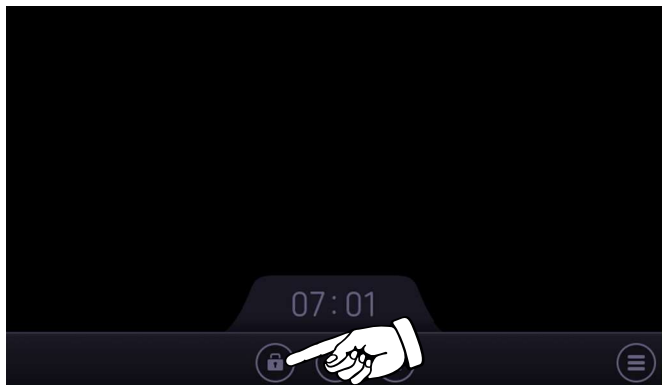

STAND ALONE TIMER

- Stand-alone timer has the performance of an egg timer.
- It can be adjusted within a range of 1 min to 9 h 59 min.
- After the adjusted time has run out, a signal tone is emitted.
- Stand-alone timer has no impact on any cooking zone.
- To activate this function touch the Hourglass icon in the menu bar.
- Adjust the numbers for the timer on the hours and minute wheels.
- Confirm the setting with the tick icon.

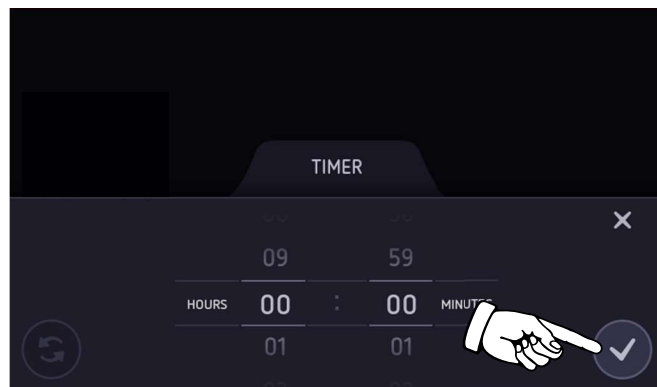
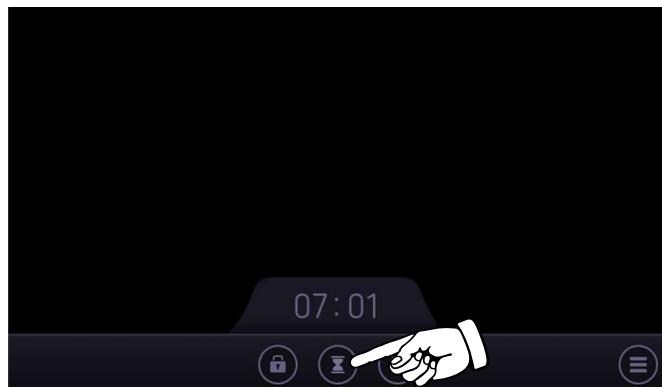

- If the timer expires a signal tone is emitted and the timer numbers are highlighted and flashing.
- Confirm the timer by touching the flashing timer values.
- The signal tone stops, and the hourglass icon is displayed again.

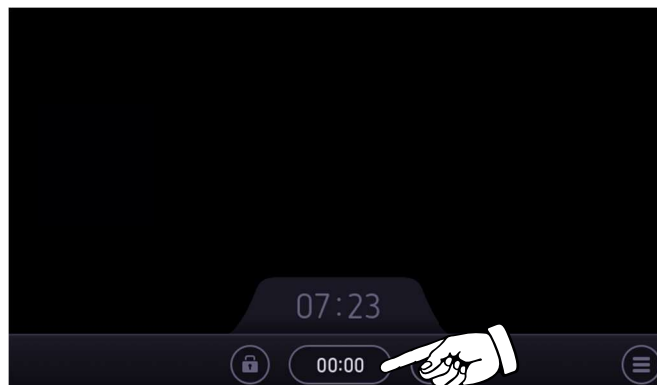
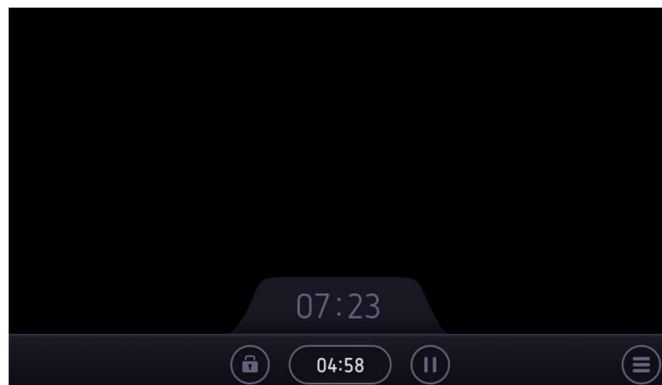

PAUSE

- Pause function is a feature to “freeze” the cooktop for max. 10 minutes.
- No cooking zone will provide any power.
- All timers (including stand-alone timer) will be paused.
- To activate the pause function touch the pause icon in the menu bar.

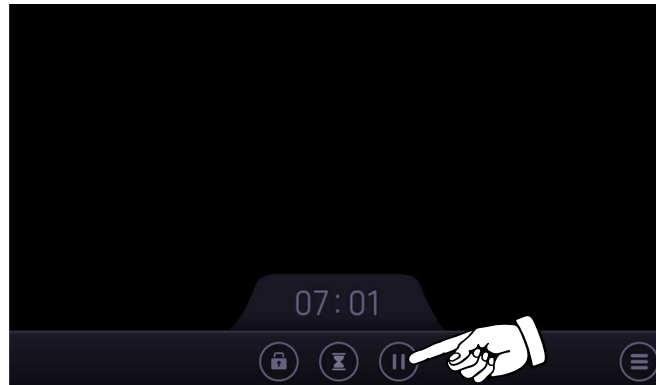

- All system states are maintained throughout the pause.
- Any timer set before and stopped during the pause, continues when the pause mode is finished
- If pause state lasts longer than 10 min, the cooktop will turn OFF.
- Booster will be canceled when activating Pause function. The power level will be set to level 9 by the system after deactivation of Pause.
- To exit the Pause function press the play button in the center of the screen.

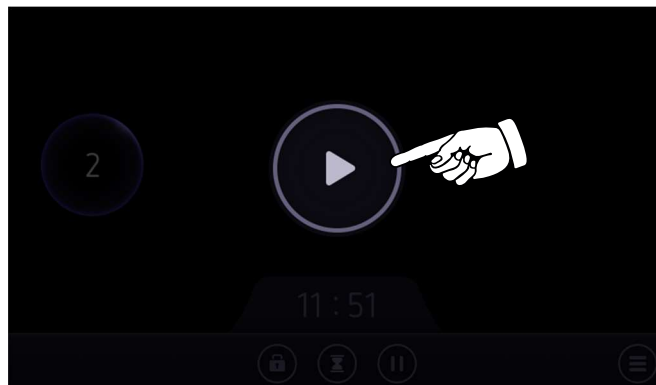

SETTINGS MENU

- The settings menu is integrated in the bottom bar of the main screen.
- To access the menu touch the menu icon in the bottom right corner.
- It contains various functions to configurate the cooktop:
 - Personalise
 - Child lock
 - Sound
 - Brightness
 - Clock
 - Language
 - Factory reset

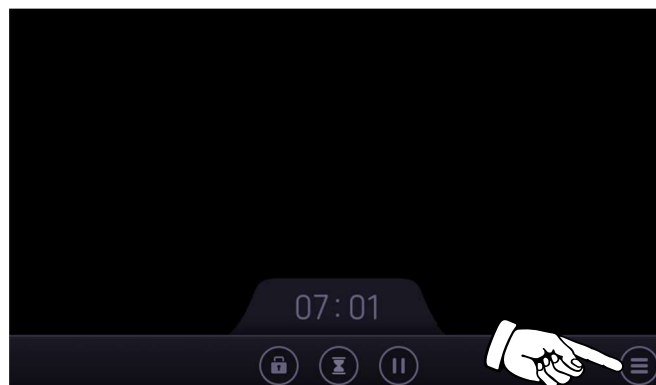

PERSONALISE

- Functions which are displayed in the menu bar in the main screen can be personalised.
- Select the Personalize icon in the settings menu.
- The black box shows the function which are displayed in the menu bar of the main screen.
- Select a function in the box to remove a function or to change the position.
- Any function can be added back selecting it from outside the box.
- Operation is confirmed by selecting the tick icon in the bottom left corner.

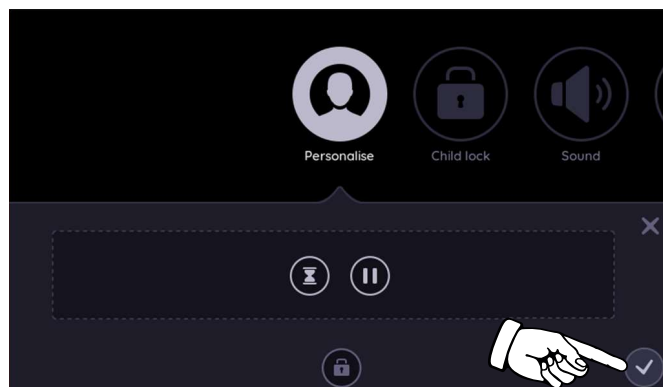
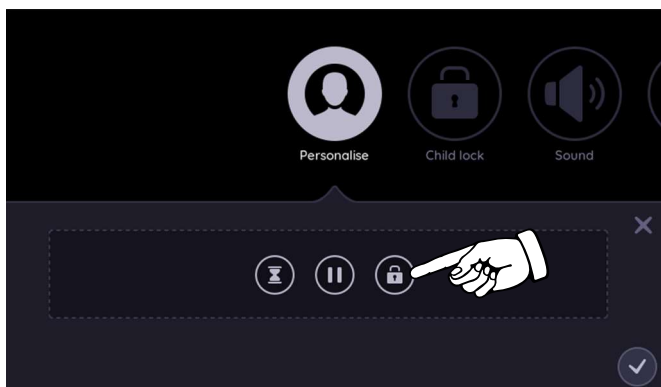

CHILD LOCK

- Child lock is a functionality to protect the cooktop against unintended operation.
- If locked, the cooktop may be turned ON, but the main screen for operating the cooktop is not displayed.
- Child lock stays active even if the power supply is interrupted and recovered. It must be de-activated manually.
- To activate select the child lock icon in the settings menu and select "ON".
- Select the confirm icon to confirm the settings.
- An info message occurs explaining that child lock gets valid after the next switch ON.

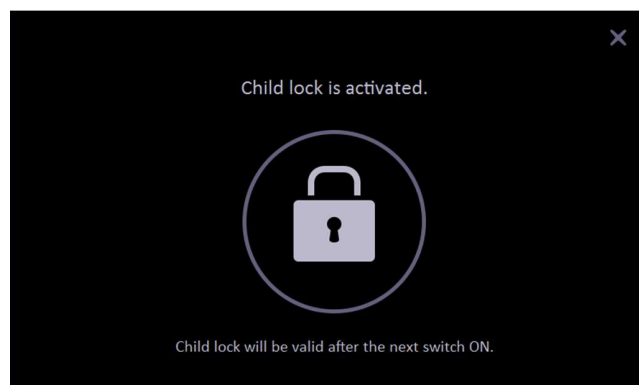
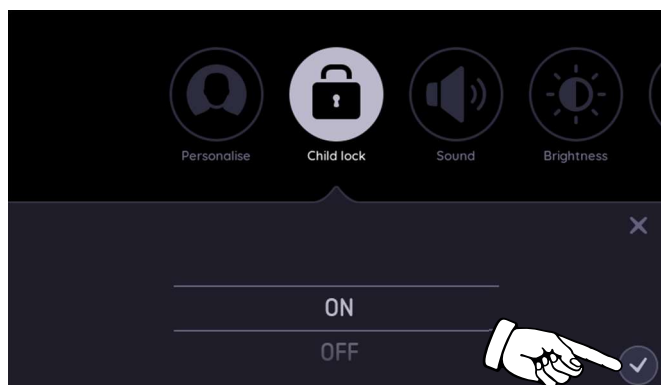

- Every time you switch on the hob, the display shows the child safety lock symbol first.
- Touch the symbol for three seconds, then the main screen shows on the display.
- To de-activate select the child lock icon in the settings menu and select "OFF".

SOUND

- Sound is adjustable on 6 different levels.
- There are two volume sliders available: notification and timer.
- To customize sound select the sound icon in the settings menu.
- Slide to the desired volume level on the slider.
- Confirm the settings by selecting the confirm icon.



Errors will always sound in maximum volume independent from the settings in the sound menu.

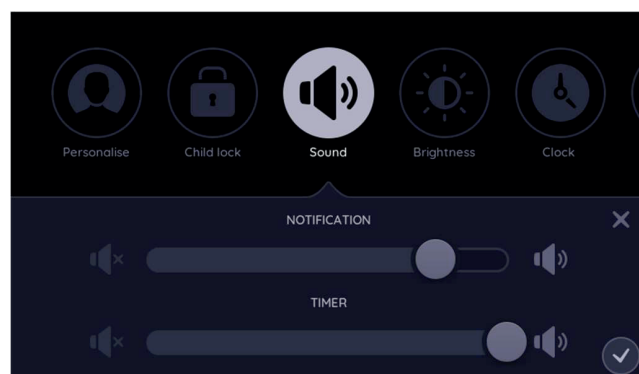

Brightness

- Brightness level can be modified to improve visibility.
- Select the brightness icon in the settings menu.
- Adjust the brightness on the slider.
- Confirm the settings by selecting the tick icon.

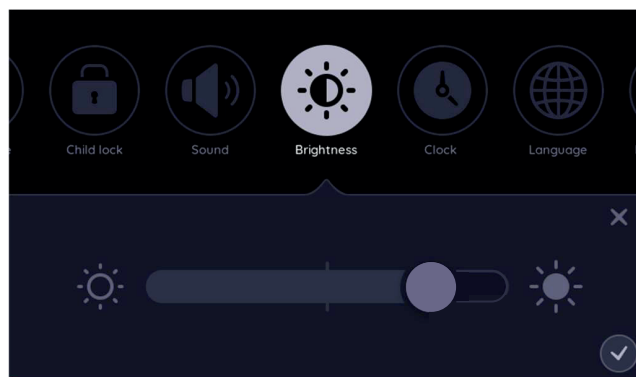

Clock

- In the clock settings menu, the time can be adjusted. The clock uses 24 h time format by default.
- Select the clock icon in the settings menu.
- Adjust the clock on the hours and minute wheels, if required change to 12 hours' time format.
- Confirm the settings by selecting the tick icon.

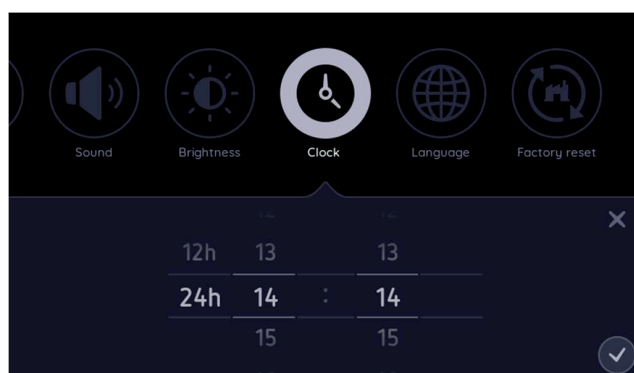

Change of language

- In the language settings it's possible to change the system language to any of the following: English, German, French, Spanish, Italian, Chinese (simplified), Korean, Vietnamese.
- In the settings menu slide the settings functions from right hand side to left hand side to get the function fully visible.
- Select the globe icon to enter the language submenu.
- Select the desired language on the wheel and confirm the settings by selecting the tick icon.

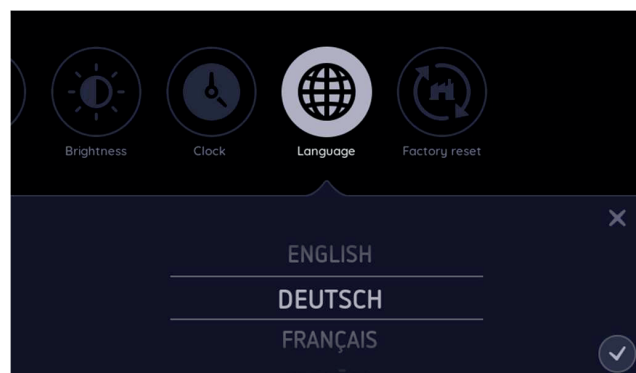
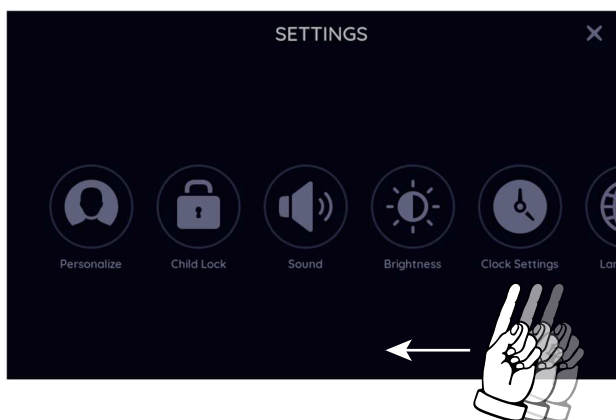

Factory reset

- Settings can be reset to factory conditions.
- In the settings menu slide the settings functions from right hand side to left hand side to get the function fully visible.
- Select the factory icon to enter the factory reset function.
- Confirm the reset by selecting the tick icon.

PROTECTION AND SAFETY WARNINGS

COOKING TIME LIMITER

•The cooking time limiter is an additional safety feature to turn OFF pots after a certain time.

COOKING LEVEL	MAX. OPERATION TIME
Melting	2 h
Keep warm	2 h
Simmering	2 h
1	10 h
1.5	10 h
2	5 h
2.5	5 h
3	5 h
3.5	5 h
4	4 h
4.5	4 h
5	3 h
5.5	3 h
6	2 h
6.5	2 h
7	2 h
7.5	2 h
8	2 h
8.5	2 h
9	1 h
P	10 min

RESIDUAL HEAT INDICATOR

•Residual Heat Indication is a safety feature to indicate that parts of the surface of the glass ceramic still keep a temperature which may cause burns when touching.

•The display shows the affected area of the surface with an H.

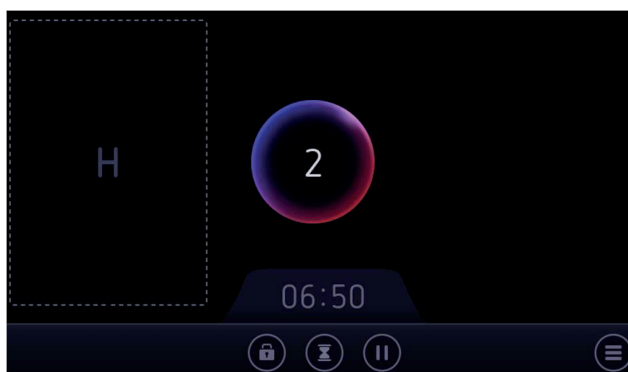

As long as the residual heat indicators are on, don't touch the heating zones and don't put any heat sensitive object on them.

APPROPRIATE COOKWARE

•In pan selection mode, a pan that is not appropriate shows in a grey color with a question mark.

•Touch the question mark to show the info message.

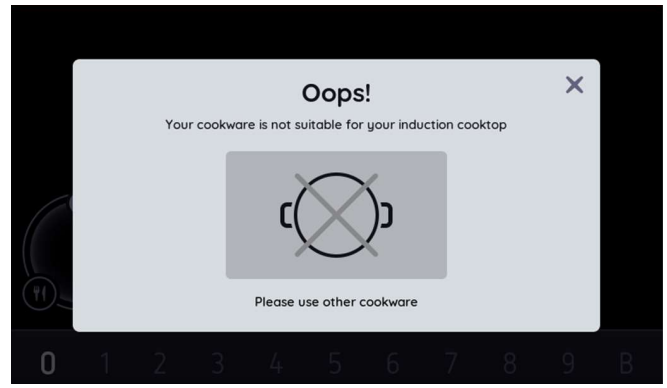
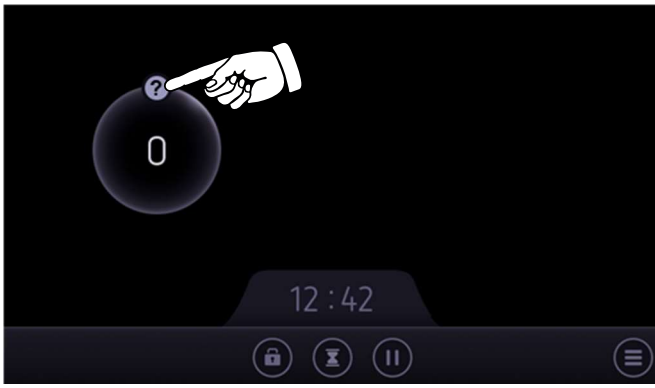

- Induction cooking requires a pan with a thick flat bottom (minimum 2.25 mm).
- Use pans made of ferromagnetic material or pans with a sandwich bottom. Other pans provide a lower performance.
- Pans made of copper, aluminum or ceramic material are not appropriate.
- Do not use pots with jagged edges or a curved base.
- To avoid scratching the glass, always lift pans off the hob - do not slide.

SMALL POT WARNING

- A coil needs to be covered at least by 10% to be able to detect and heat up cookware.
- As cookware can be placed covering several coils but each coil less than 10% of the surface, small pots between 100mm and 145mm cannot be detected correctly at every position of the cooktop. In this case, the pot cannot be heated.
- In pan selection mode, a pan that is not big enough shows in a grey color with an exclamation mark.
- If the pot is selected and a power level is set, the requested power level is displayed in red color
- Touch the exclamation mark to show the info message.

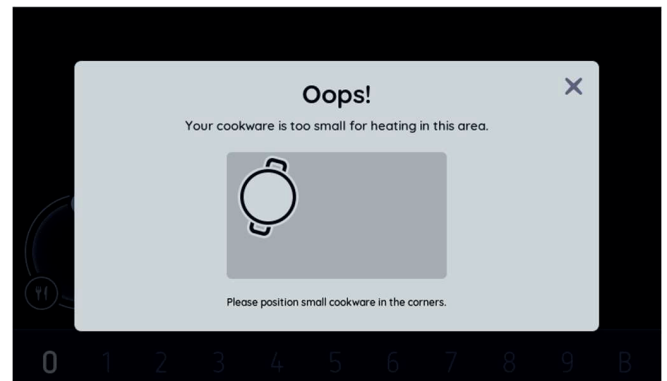
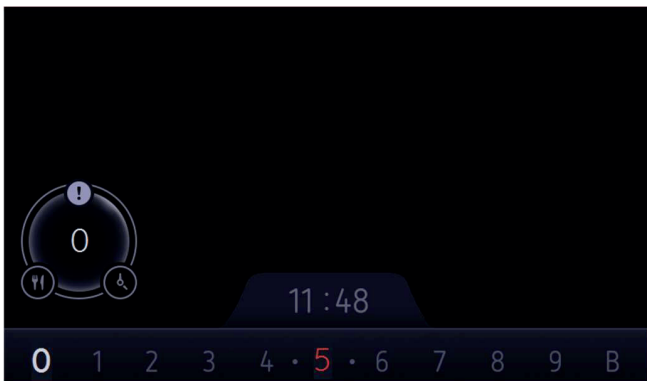

Move the pot to a corner of the cooktop to get more coil coverage

POWER CONFLICT

- A power conflict can be caused by an unfavorable pot positioning in combination with cooking levels which strongly differ from each other.
 - Due to safety reasons, the pot with the lower power level has priority (here pot 1).
- The other pot (here pot 2) can only get the same power out of the conflict coil as needed to heat pot 1.

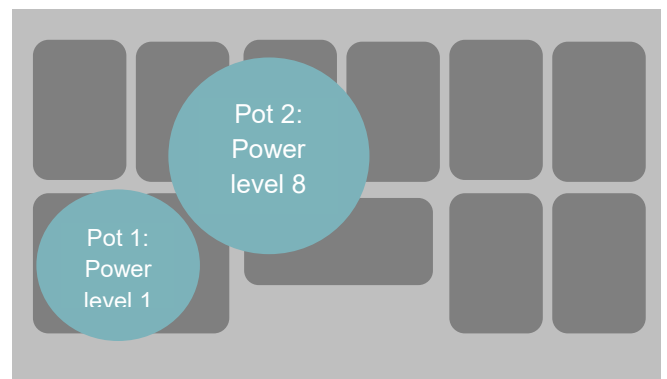

Example:

- Pot with power level 8 is moved close to the pot with power level 1.
- The power level of the moved pot is decreased to the max possible power level (here e.g., level 3).
- The slider shows the original set power level (here level 8) in red color and the maximum possible power level (here e.g., level 3) in white color.
- The pot is displaying an exclamation mark to show that the pot has a conflict.
- Select the exclamation mark to get an info message.
- The info message opens, advising to move the pots further apart.

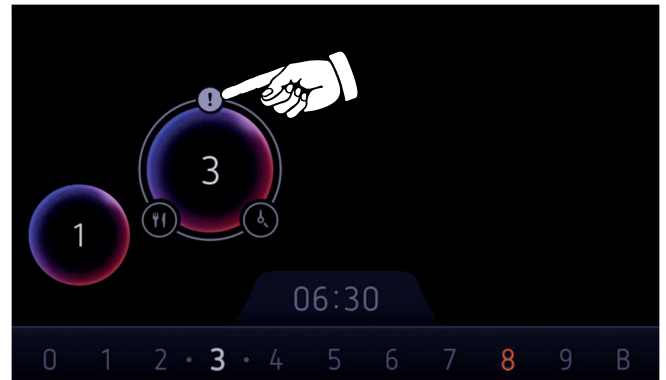
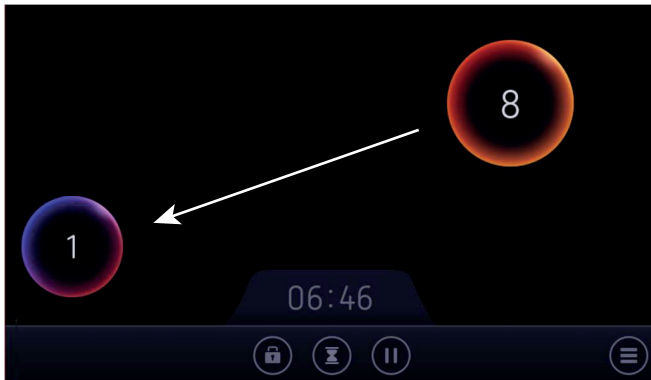

The same scenario will occur when moving a pot with lower power level towards the pot of higher power level coil (here e.g. Pot 1 towards Pot 2).
Due to safety reasons the pot with the lower power level has priority.

PROTECTION AND SAFETY WARNINGS

COMMON PROBLEMS	CAUSE	POSSIBLE SOLUTION
Cooling fan keeps working after the hob is switched on	Cooling	Standard procedure
The hob makes weird noises	Induction causes some noises like chirping, humming, acoustic signals	These noises can't be fully avoided. -Try moving the pots -Make sure the pot's underside is clean -Try different cookware -Composite pans can be noisy -Use pans with a flat bottom
The hob doesn't work, the display doesn't turn on	Power is not being supplied	Check fuses Check the hob is plugged in
When the hob is switched on, the fuse blows out	Wrong wiring connection	Check wiring diagram
The glass is cracked	The glass is damaged	Don't use the hob, call service

ERROR CODE	CAUSE	POSSIBLE SOLUTION
E2 Er21 Er91 Er92	Device temperature too high	Put the device in stan-by mode. Remove any cookware from the hob. Let the hob cool down for some time. If the problem persists contact service.
E1 Er31 Er45 Er61 Er63	Wrong wiring connection	Check wiring diagram
U400	Over voltage	The secondary voltage of the power supply is too high Check for correct electrical connection

CLEANING AND MAINTENANCE



Fig.1



Fig.2



Fig.3

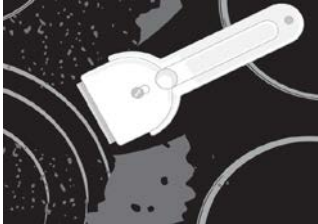

Fig.4



Fig.5

Ceramic glass hob should be cleaned only when completely cooled down, preferably after each use, otherwise even the slightest stains remaining after cooking may burn into the hob surface with each following use.

For regular maintenance of ceramic-glass hob use special cleansing agents, produced in such way to create protective film upon the surface.

Before each use, wipe the dust and other particles from the hob, they may scratch the surface (Fig. 1).

Use of steel wool, abrasive cleaning sponges, and abrasive detergents can scratch the surface of the hob. The surface may also be damaged by the use of aggressive sprays and inappropriate liquid chemicals (Fig.1 and 2).



Pattern marks can be erased by the use of aggressive cleansing agents or rough and damaged cookware bottoms (Fig. 2).

Minor stains are removed with moist soft cloth; after that the surface should be wiped dry (Fig. 3).

Water stains are removed with gentle vinegar solution, but you must not wipe the frame with it (certain models only), since it may lose its glow. Never use any aggressive sprays or limestone removers (Fig. 3).

Major stains are removed with special ceramic-glass cleansers.

Follow strictly the manufacturer's instructions.

Be careful to remove any remains of cleansing agent from the hob surface, otherwise they will be heated during the next use and can damage the hob (Fig. 3).

Stubborn and burnt stains are removed with special ceramic-glass scraper. Be careful, however, not to touch the hotplate surface with the scraper handle (Fig. 4).

Handle the scraper with utmost care to avoid injuries!

Sugar and sugar containing food may permanently damage the ceramic-glass hob surface (Fig. 5), so the remains of sugar and sugar containing food must be scraped off from the hob surface immediately, when the hotplates are still hot (Fig. 4).

Discoloring of ceramic-glass hob has no effect whatsoever on its operation and stability. In most cases, it appears as the consequence of burnt in food remains, or as a result of dragging pots and pans (especially aluminium or copper bottom cookware) across the surface, and such discoloring is rather hard to remove.



All described faults are mostly esthetical and do not affect directly the operation of the appliance. Remedy of such faults is not covered by warranty.

LABEL



Foster S.p.A

Via M.S. Ottone 18-20
42041 Brescello (RE) – Italy

www.fosterspa.com